

80 × 80 × 25 mm

XJHFAN

Bearing Type: Ball/Sleeve bearing

Air Flow: 28~42CFM

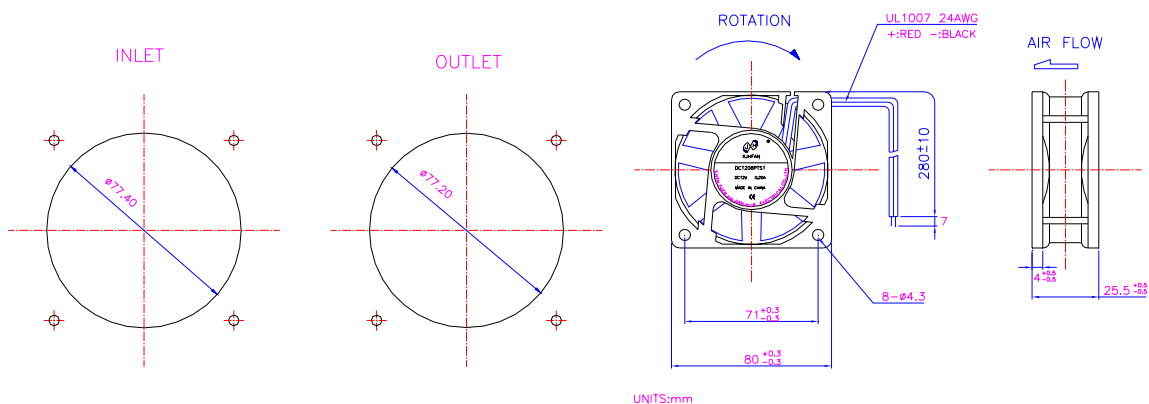

编号 Model	电压 Rating Voltage(VDC)	电流 Power Current (AMP)	功率 Power Consumption (WATTS)	轴承 Bearing Ball Sleeve	转速 Speed (RPM)	风量 Air Flow (CFM)	风压 Static Pressure (Inch-H ₂ O)	噪声 Noise (dBA)
DC1208PTS1	12	0.20	2.4	S	2850	37	0.17	33
DC1208PTS2	12	0.19	2.3	S	2700	36	0.16	30
DC1208PTS3	12	0.11	1.4	S	2300	31	0.12	26
DC1208PTB1	12	0.19	2.3	B	3000	39	0.18	35
DC1208PTB2	12	0.17	2.1	B	2900	38	0.17	34
DC1208PTB3	12	0.11	1.4	B	2500	33	0.13	29
DC2408PTS1	24	0.11	2.6	S	3000	39	0.18	35
DC2408PTS2	24	0.08	1.9	S	2650	34	0.16	32
DC2408PTS3	24	0.06	1.5	S	2200	29	0.11	26
DC2408PTB1	24	0.11	2.6	B	3200	42	0.23	37
DC2408PTB2	24	0.08	1.9	B	2800	35	0.20	31
DC2408PTB3	24	0.06	1.5	B	2500	33	0.13	29

